



# Power Analyzer PAN 311



---

# Table of Contents

<b>Technical data</b> .....	2
Technical data.....	2
<b>Front panel description</b> .....	8
Front panel description.....	8
<b>Key pad actions - Setup mode</b> .....	9
Key pad actions - Setup mode.....	9
<b>Key pad actions - View mode</b> .....	14
Key pad actions - View mode.....	14

# Technical data

## Technical data

<b>Rated input voltage:</b>	line to neutral: 185 V to 460 V; line to line: 320 V to 800 V
<b>Rated input current (through CT):</b>	5 A
<b>Type of electrical system:</b>	three phase, balanced/unbalanced load, with/without neutral
<b>Power supply:</b>	24 VAC -15% +10%, 50-60 Hz
<b>Output:</b>	Serial port RS485, MODBUS communication, 9600 bit/s, 1 start bit, 8 data bit, no parity, 1 stop bit
<b>Overload protection:</b>	continuously 6 A and 120% of rated input voltage; for 500 ms: 36 A and 200% of rated input voltage
<b>Display menus:</b>	total 18 menus (see 18-menu display)
<b>Display refresh time:</b>	700 ms.
<b>Current transformer ratio:</b>	1 to 999
<b>Voltage transformer ratio:</b>	1.0 to 99.9
<b>EMC:</b>	emission EN50084-1 (residential class A); immunity EN61000-6-2 (industrial class A)
<b>Approval:</b>	CE, CSA and UL
<b>Standard:</b>	safety EN61010 – IEC-60664
<b>Connection:</b>	screw type; maximum cable cross section: 2.5 mm AWG
<b>Protection degree:</b>	front IP40; terminal IP20
<b>Mounting:</b>	DIN-rail
<b>Operating temperature:</b>	-10 to +60°C (14 to 140°F)
<b>Weight:</b>	about 400 g (14.1 oz) incl. packing
<b>Part No.</b>	40 501189

Dimensions

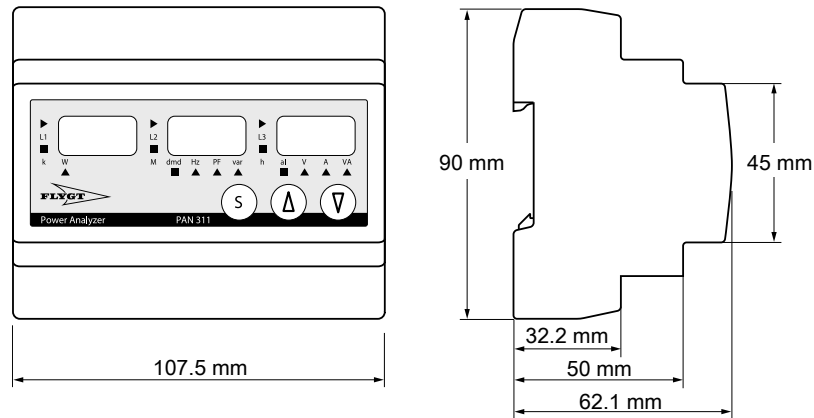

Figure 1

Connection/Electric diagram

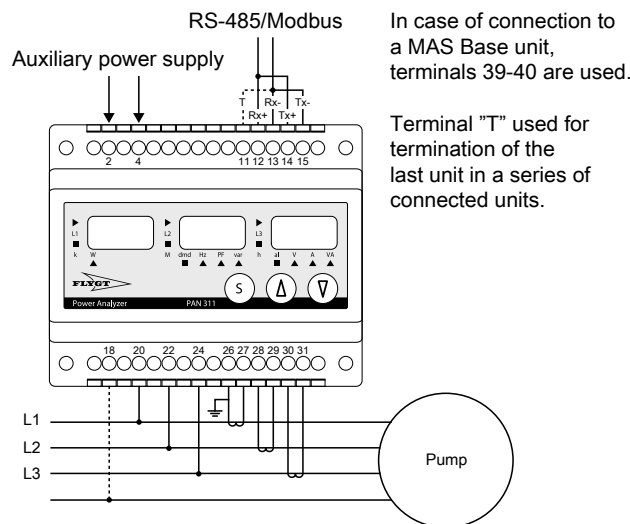

Figure 2



**WARNING:** The current input can be connected to the line ONLY through current transformer; the connection of the CT's to earth MUST be carried out according to the electric diagram shown above; when the CT is connected to earth, a leakage current from 0 to 1.8 mA max is generated depending on input impedance, connection and the line voltage measured by the instrument.



**Electrical Hazard:**

EN

Electrical work must only be carried out by a qualified electrician and in accordance with local regulations. During installation, all equipment must be disconnected from the power supply without any possibility of being made live. Terminals 26, 27, 28, 29, 30 and 31 are connected to voltages up to 800 V.

CS

Práce na elektrickém zařízení musí provádět pouze kvalifikovaný elektrikář podle místních předpisů. Během instalace musí být veškeré zařízení odpojeno od napájení bez jakékoliv možnosti, že by se mohlo dostat pod napětí. Svorky 26, 27, 28, 29, 30 a 31 jsou připojeny k napětím až 800 V.

DA

Arbejde på elektriske installationer må kun udføres af en autoriseret elektriker og i overensstemmelse med de lokale forskrifter. Under installationsarbejdet skal al udstyret være koblet fra strømforsyningen uden nogen muligheder for at kunne aktiveres. Stik 26, 27, 28, 29, 30 og 31 er tilsluttet spændinger på op til 800 V.

DE

Arbeiten an der Elektrik sind ausschließlich von einem ausgebildeten Elektriker und gemäß den geltenden Bestimmungen vorzunehmen. Während der Installation ist die Stromversorgung zu allen Geräte zu unterbrechen und jede Möglichkeit auszuschließen, dass diese wieder eingeschaltet wird. Anschlüsse 26, 27, 28, 29, 30 und 31 können mit Spannungen von bis zu 800 V versorgt werden.

EL

Οι ηλεκτρολογικές εργασίες πρέπει να εκτελούνται μόνο από ειδικευμένο ηλεκτρολόγο και σύμφωνα με τους τοπικούς κανονισμούς. Κατά τη διάρκεια της εγκατάστασης, ολόκληρος ο εξοπλισμός πρέπει να είναι αποσυνδεδεμένος από την ηλεκτρική τροφοδοσία, χωρίς να υπάρχει το ενδεχόμενο να τεθεί υπό τάση. Οι ακροδέκτες 26, 27, 28, 29, 30 και 31 συνδέονται σε τάσεις μέχρι και 800 V.

ES

Los trabajos eléctricos deberán encargarse exclusivamente a un electricista cualificado y cumplir la normativa local. Durante la instalación, todo el equipo deberá permanecer desconectado de la alimentación eléctrica de manera que sea imposible que reciba corriente. Los bornes 26, 27, 28, 29, 30 y 31 están conectados a tensiones que pueden llegar a 800 V.

ET

Elektritööd võib teha üksnes kvalifitseeritud elektrimontöör ning tööde teostamisel tuleb järgida kõiki piirkonnas kehtivaid nõudeid. Paigaldamise ajaks tuleb kõik seadmed vooluvõrgust eraldada ning igasugune võimalus nende voolu alla sattumiseks peab olema välistatud. Klemmid 26, 27, 28, 29, 30 ja 31 ühendatakse kuni 800-voldise pingega.

FI

Sähkötyöt saa tehdä vain pätevä sähköasentaja, ja niissä on noudatettava paikallisia määräyksiä. Asennustöiden ajaksi laitteet on aina kytkettävä irti sähköverkosta ja huolehdittava, ettei niitä voi vahingossa kytkeä päälle. Liittimet 26, 27, 28, 29, 30 ja 31 liitetään enintään 800 V jännitteeseen.

FR

Les travaux électriques doivent exclusivement être effectués par un électricien professionnel et conformément aux réglementations locales. Pendant l'installation, l'ensemble de l'équipement doit être débranché de l'alimentation électrique et aucune partie ne doit rester sous tension. Les terminaux 26, 27, 28, 29, 30 et 31 sont branchés sur des tensions pouvant atteindre 800 V.

HU

Elektromos munkákat csak szakképzett villamos szakember végezhet, betartva a helyi előírásokat. Telepítés során minden berendezést le kell választani az elektronos hálózatról úgy, hogy az ne legyen visszakapcsolható. A 26, 27, 28, 29, 30 és 31 végberendezések maximum 800 V feszültségre kapcsolódnak.

**Electrical Hazard:**

IT

Le connessioni elettriche vanno effettuate esclusivamente da un elettricista qualificato in conformità alle normative locali. Durante l'installazione, tutta l'apparecchiatura va disconnessa dall'alimentazione di rete senza alcuna possibilità che diventi sede di potenziale elettrico. I terminali 26, 27, 28, 29, 30 e 31 sono connessi a tensioni fino ad 800 V.

LT

Elektros darbus turi atlikti tik kvalifikuotas elektrikas, laikydamasis vietinių taisyklių. Montavimo metu visa įranga turi būti atjungta nuo srovės tiekimo; neturi būti nei menkiausias srovės tiekimo atsinaujinimo galimybės. 26, 27, 28, 29, 30 ir 31 gnybtai prijungiami prie iki 800 V įtampos.

LV

Tikai kvalificēts elektriķis ir tiesīgs veikt elektrības darbus atbilstoši vietējiem noteikumiem. Uzstādīšanas laikā visam aprīkojumam jābūt atvienotam no energoapgādes, izslēdzot jebkādu nejaušas ieslēgšanas varbūtību. Terminālu Nr. 26, 27, 28, 29, 30 un 31 pieslēdz spriegumam līdz 800 V.

NL

Werkzaamheden aan elektrische installaties mogen alleen conform de geldende voorschriften worden uitgevoerd door vakbekwame personen. Tijdens werkzaamheden aan elektrische installaties moet alle apparatuur op een beveiligde wijze spanningsloos zijn. De aansluitingen 26, 27, 28, 29, 30 en 31 zijn aangesloten op een spanning tot 800 V.

PL

Prace elektryczne muszą być wykonywane przez wykwalifikowanych elektryków zgodnie z obowiązującymi przepisami. Podczas instalacji sprzęt musi być odłączony od źródła zasilania, tak aby niemożliwe było wystąpienie napięcia na jakimkolwiek elemencie. Złącza 26, 27, 28, 29, 30 i 31 są podłączone do napięcia mogącego osiągać 800 V.

PT

O trabalho eléctrico deve ser realizado por um electricista qualificado em conformidade com os regulamentos locais. Durante a instalação, todo o equipamento deve ser desligado da fonte de alimentação eléctrica sem nenhuma hipótese de activação eléctrica. Os terminais 26, 27, 28, 29, 30 e 31 estão ligados a tensões de 800 V no máximo.

SK

Elektrické práce môže uskutočňovať iba kvalifikovaný elektrikár, pričom v súlade s platnými predpismi. Pri inštalácii sa všetky zariadenia musia odpojiť od napájacieho zdroja. Musí sa vylúčiť akákoľvek možnosť pripojenia napätia. Svorky 26, 27, 28, 29, 30 a 31 sú pripojené na napätia dosahujúce až 800 V.

SL

Električarska dela mora izvesti kvalificiran strokovnjak - električar, v skladu z lokalnimi pravili in zahtevami. Med instalacijo morajo biti vse naprave izključene in ločene od omrežja, ter zavarovane pred nezaželenim vklopom. Priključki 26, 27, 28, 29, 30 in 31 so priključeni na napetost do 800 V.

SE

Elarbeten får endast utföras av en behörig elektriker och i enlighet med gällande lagstiftning. Under installationen måste all utrustning vara bortkopplad från strömförsörjningen och ska inte kunna göras strömförande. Uttagen 26, 27, 28, 29, 30 och 31 är anslutna till spänning på upp till 800 V.

**NOTICE:**

EN

Do not connect the instrument to the output side of a variable frequency drive (between the VFD and the pump) in order to avoid malfunctioning or damage.

CS

Nepřipojujte přístroj k výstupní straně budiče s proměnným kmitočtem (mezi budič a čerpadlo), aby nedošlo k poruše nebo poškození.

DA

For at forhindre fejl eller beskadigelse må instrumentet ikke sluttes til udgangssiden af et variabelt frekvensdrev (mellem VFD'et og pumpen).

DE

Zur Vermeidung von Funktionsstörungen bzw. Beschädigungen darf das Gerät nicht an die Ausgangsseite eines frequenzgestellten Antriebs (zwischen dem Mehrfrequenzmonitor und der Pumpe) angeschlossen werden.

EL

Για την αποφυγή δυσλειτουργίας ή βλάβης, μη συνδέετε το όργανο στην πλευρά εξόδου ενός συστήματος μετάδοσης κίνησης μεταβλητής συχνότητας (μεταξύ του VFD και της αντλίας).

ES

Para evitar que se produzcan fallos de funcionamiento o averías, no conecte el aparato en el lado de la salida de un variador de velocidad (VFD), es decir, entre éste y la bomba.

ET

Töökindluse tagamiseks ja rikete vältimiseks ei tohi seadet ühendada reguleeritava sagedusega ajami väljundahelasse (ajami ja pumba vahele).

FI

Älä liitä laitetta muuttuvataajuuskäytön lähtöpuolelle (käytön ja pumpun välille), jotta järjestelmän toiminta ei häiriinny tai järjestelmä vaurioidu.

FR

Afin d'éviter tout risque de dysfonctionnement ou de dommage, ne branchez pas l'appareil sur le côté sortie d'un système d'entraînement à fréquence variable (VFD) (entre le VFD et la pompe).

HU

A hibás működés és károsodás elkerülése érdekében ne csatlakoztassa a készüléket a változtatható frekvencia-szabályozó kimeneti oldalára (a VFD és a szivattyú közé).

---



**NOTICE:**

IT

Non connettere lo strumento all'uscita di un'unità a frequenza variabile (fra l'unità a frequenza variabile e la pompa) onde evitare funzionamenti errati o danni.

LT

Nejunkite prietaiso prie kintamo dažnio pavaros išvado pusės (tarp kintamo dažnio pavaros ir siurblio), kad išvengtumėte blogo veikimo ar pažeidimų.

LV

Ierīci nedrīkst pievienot mainīgas frekvences pievada izvades pusei (starp mainīgās frekvences pievadu un sūkni), lai izvairītos no ierīces nepareizas darbības vai bojājumiem.

NL

Sluit het apparaat niet aan op de uitgangszijde van een aandrijving met variabele frequentie (tussen de VFD en de pomp) omdat dit storing of schade kan veroorzaken.

PL

Aby uniknąć niewłaściwego działania lub uszkodzenia urządzenia, nie należy go podłączać do wyjścia napędu ze zmienną częstotliwością (między napędem VFD a pompą).

PT

Não ligue o instrumento à saída de uma engrenagem motriz de frequência variável (entre a VFD e a bomba) de forma a evitar mau funcionamento ou avaria.

SK

Nepripájajte prístroj k výstupu pohonu s frekvenčnou reguláciou (medzi VFD a čerpadlo). Takto vylúčíte riziko chybnéj funkcie alebo poškodenia.

SL

Ne priključujte instrumenta na izhodno stran variabilnega frekvenčnega pogona (med VFD in črpalco), s tem se izognete nepravilnemu delovanju ali poškodbam naprave.

SE

Anslut aldrig instrumentet till utgångssidan på en frekvensomriktare (mellan frekvensomriktaren och pumpen) eftersom det då kan uppstå skador och funktionsfel.

---

# Front panel description

## Front panel description

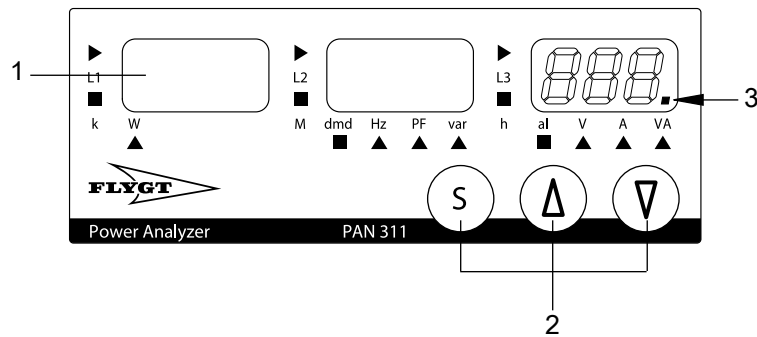

1. **Display**

LED display with alphanumeric indications to:

- display configuration parameters;
- display all the measured variables.

2. **Key pad**

To program the configuration parameters and the display of variables.



Key to enter programming and confirm selections;



Keys to:

- program values;
- select functions;
- step through view menus.

3. **Decimal point blinking**

When measuring voltage: Phase to phase

When measuring power: Wrong connection

<b>k</b>	kilo (1000)
<b>W</b>	Active power (Watt)
<b>M</b>	Mega (10 <sup>6</sup> )
<b>dmd</b>	Displayed value is an average formed over 1 - 30 minutes
<b>Hz</b>	Frequency
<b>PF</b>	Power factor
<b>var</b>	Reactive power (voltampere reactive)
<b>h</b>	hours, used to indicate kWh
<b>al</b>	alarm
<b>V</b>	Volt
<b>A</b>	Ampere
<b>VA</b>	VoltAmpere

Figure 3



# Key pad actions - Setup mode

## Key pad actions - Setup mode

### NOTICE:





Read the safety precautions and the specification carefully.  
Connect wires according to the wiring diagram.





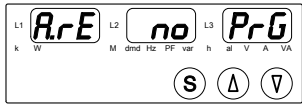
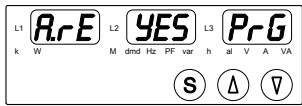

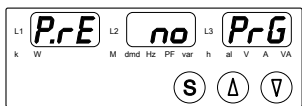
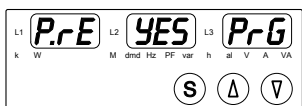
### Key pad functions



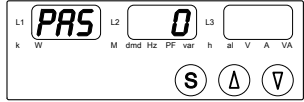

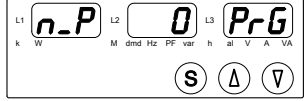

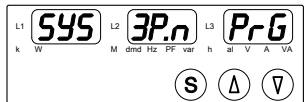

-  To access **Setup** mode and to confirm setting value.
-  In **Setup** mode (in display: "PrG"): Scroll to the next function or increase parameter value.
-  In **Setup** mode: Scroll to the previous function or decrease parameter value.

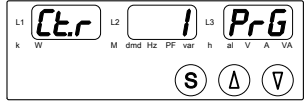



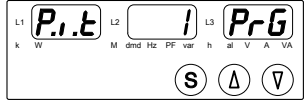

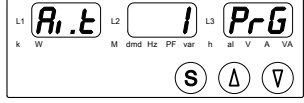

NOTICE: To accept all changes you must enter the end parameter, see [Figure 36](#): (page 13).

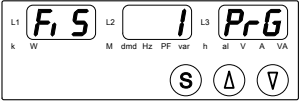

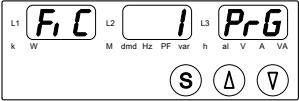
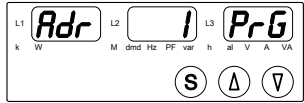
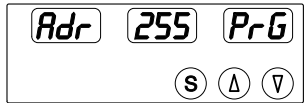
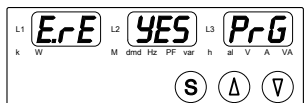

**Table 1: Set the PAN311 using the key pad and go through the following steps:**

			Default
1.	 <p>Figure 4</p>  <p>Figure 5</p>	<p>Press 'S' once, when "A.rE" is shown, alarms can be reset by pressing  or  to select 'yes'. Confirm by pressing 'S'.</p> <p>"A.rE" = Alarm reset.</p>	No
2.	 <p>Figure 6</p>  <p>Figure 7</p>	<p>Press 'S', when "P.rE" is shown. The Wdmd and Amax can be reset by using  or  to select 'yes'. Confirm by pressing 'S'.</p> <p>"P.rE" = Peak reset. Resets the Wdmd max and Amax.</p>	No

			Default
3.	 <p>Figure 8</p>  <p>Figure 9</p>	<p>Press 'S' once, when "PAS" is shown. Enter correct password (default is '0') using ▲ and ▼. Confirm by pressing 'S'.                  "PAS": if you enter the correct password you access the setup main menu.</p>	0
4.	 <p>Figure 10</p>  <p>Figure 11</p>	<p>On the first menu of the <b>setup main menu</b>, "n_P" (new password) is shown. If you want to change password, press 'S' to setup mode "PrG", then use ▲ and ▼ to change value. Confirm by pressing 'S'. Press ▲ to go to the next parameter.                  PrG = Program (setup) mode.</p>	0
5.	 <p>Figure 12</p>  <p>Figure 13</p>	<p><b>SYS</b> (system selection). If you want to change system mode press 'S' to setup mode "PrG" and choose the correct electrical system with ▲ and ▼. Confirm by pressing 'S'. Press ▲ view mode "r.03" to go to the next parameter.                  "SYS": electrical system selection, choose the correct electrical system.                  "3P.n": 3-phase unbalanced load with or without neutral.                  "3P.A": 3-phase ARON.                  "3P": 3-phase balanced load.                  "2P": 2-phase                  "1P": 1-phase</p>	3P.n

			Default
6.	 <p>Figure 14</p>  <p>Figure 15</p>	<p>"Ct.r" (current transformer ratio). Press 'S' to setup mode "PrG" and enter value (1 - 999) using ▲ and ▼. Confirm by pressing 'S'. <b>Example:</b> If the primary of the CT is 300A and the secondary is 5A, the CT ratio is 60 (obtained from the calculation: 300/5). Press ▲ in view mode "r.03" to go to the next parameter.</p>	1
7.	 <p>Figure 16</p>  <p>Figure 17</p>	<p>"Ut.r" (voltage transformer ratio). Press 'S' to setup mode "PrG" and enter value (1.0 to 99.9) using ▲ or ▼ and confirm by pressing 'S'. <b>Example:</b> If the primary of the VT is 5kV and the secondary is 100V, the VT ratio is 50 (obtained from the calculation: 5000/100). Press ▲ in view mode "r.03" to go to the next parameter.</p>	1
8.	 <p>Figure 18</p>  <p>Figure 19</p>	<p>"P.i.t" (power integration time), is used to calculate 'Power dmd' (Power mean value). Enter time over which the average is formed (1 - 30 minutes) with ▲ or ▼ in setup mode "PrG" and confirm by pressing 'S'. Press ▲ in view mode "r.03" to go to the next parameter.</p>	15
9.	 <p>Figure 20</p>  <p>Figure 21</p>	<p>"A.i.t" (Amperage integration time) is used to calculate 'Thermal current'. Enter time over which the average is formed (1 - 30 minutes) with ▲ or ▼ in setup mode "PrG" and confirm by pressing 'S'. Press ▲ in view mode "r.03" to go to the next parameter.</p>	1

			Default
10.	 <p>Figure 22</p>  <p>Figure 23</p>	<p>"Fi.s" (filtering range) is used to set the operating range of the digital filter with ▲ or ▼ in setup mode "PrG" and confirm by pressing 'S'. The value is expressed as % of the full scale value. Press ▲ in view mode "r.03" to go to the next parameter.</p>	2
11.	 <p>Figure 24</p>  <p>Figure 25</p>	<p>"Fi.c" (filtering coefficient). Enter value (1 - 16) with ▲ or ▼ in setup mode "PrG" and confirm with 'S'. A higher value increases the stability and the settling time of the measurements. Press ▲ in view mode "r.03" to go to the next parameter.</p>	2
12.	 <p>Figure 26</p>  <p>Figure 27</p>	<p>"AL-" (Overvoltage: Line-Neutral). Press 'S' to setup mode "PrG" and set the trip limit with ▲ or ▼. Confirm with 'S'. Voltage exceeding entered value will trigger an alarm (blinking LED: Al). Press ▲ in view mode "r.03" to go to the next parameter.</p>	253
13.	 <p>Figure 28</p>  <p>Figure 29</p>	<p>"AL_" (Undervoltage: Line-Neutral). Press 'S' to setup mode "PrG" and set the trip limit with ▲ or ▼. Confirm by pressing 'S'. Voltage below entered value will trigger an alarm (blinking LED: Al). Press ▲ in view mode "r.03" to go to the next parameter.</p> <p><b>Note:</b> If Overvoltage and Undervoltage trip limits are the same, both alarms are disabled.</p>	207

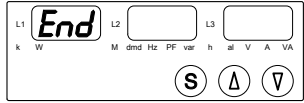
			Default
14.	 <p>Figure 30</p>  <p>Figure 31</p>	<p>"AL.n" (Overcurrent in the Neutral). Press 'S' to setup mode "PrG" and set the trip limit with ▲ or ▼. Confirm by pressing 'S'. A current through neutral exceeding the trip limit will trigger an alarm (LED: Al). If the 'AL.n' value is 0, the neutral current alarm function will be disabled. The alarm status is displayed by a blinking LED: see <a href="#">Key pad actions - View mode</a> (page 14), menu 5. Press ▲ in view mode "r.03" to go to the next parameter.</p>	0.10
15.	 <p>Figure 32</p>  <p>Figure 33</p>	<p>"Adr" (Instrument serial port address). Press 'S' to setup mode "PrG" and enter value (1 - 255) with ▲ or ▼. Confirm with 'S'. Press ▲ in view mode "r.03" to go to the next parameter.</p>	255
16.	 <p>Figure 34</p>  <p>Figure 35</p>	<p>"ErE" (Reset of energy and hour meters). Press 'S' to setup mode "PrG" and use ▲ or ▼. Confirm by pressing 'S'. Press ▲ in view mode "r.03" to go to the next parameter.</p>	No
17.	 <p>Figure 36</p>	<p>"End".  <b>To confirm new selected values and leave the setup menu, press the 'S' key!</b> To remain in the setup menu, press ▲ or ▼. <b>Note!</b> Being in the Setup menu: In case no key is pressed for 30 sec, the display reverts to the View mode and possible parameter settings are lost.</p>	

# Key pad actions - View mode

## Key pad actions - View mode

### Key pad functions



-  In **View** mode (in display: "r.03"): Scroll to the next displayed system variable.
-  In **View** mode (in display: "r.03"): Scroll to the next displayed system variable.



Figure 37: Menu 1

Phase voltage (phase to neutral) for each phase.  
V L1-N, V L2-N, V L3-N.



Figure 38: Menu 2

Phase to phase voltage. VL12, VL23, VL31.  
Decimal points blink.

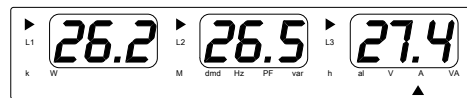

Figure 39: Menu 3

Phase current of each phase.



Figure 40: Menu 4

dmd<sup>1</sup>-value of three phase current.

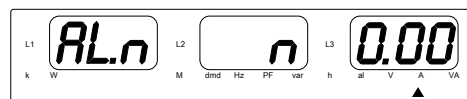

Figure 41: Menu 5

Neutral current.  
If neutral current alarm is active, "AL.n" is shown.  
If neutral current alarm is not active, "n" is shown.



Figure 42: Menu 6

Active power of each phase. WL1, WL2, WL3.  
Decimal points blink if power is negative (generated power, or wrong polarity connection of CT).

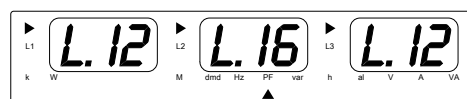

Figure 43: Menu 7

Power factor of each phase, PF L1, PF L2, PF L3. The example shows a power factor of 0.12, 0.16 and 0.12 for an electric motor.

<sup>1</sup> dmd = demand means average value during selected integration time from 1 to 30 minutes. Dmd is used by electricity suppliers as input for billing.





Figure 44: Menu 8

Reactive power of each phase. var1, var2, var3.  
 Decimal points blink if power is negative (generated power, or wrong polarity connection of CT).



Figure 45: Menu 9

Apparent power (VA) of each phase, VA L1, VA L2, VA L3.



Figure 46: Menu 10

System active power (W), system reactive power (var), and system apparent power (VA).

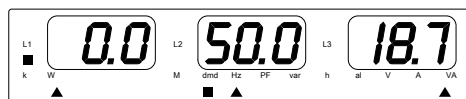

Figure 47: Menu 11

dmd<sup>1</sup>-value of system active power (W), system frequency Hz dmd\*-value of apparent power (VA).

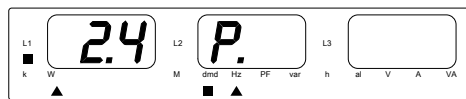

Figure 48: Menu 12

dmd<sup>1</sup>-value of maximum system active power (W).  
 P = Peak.



Figure 49: Menu 13

Total active energy consumption kWh. The screen value is 2951646.1 kWh.



Figure 50: Menu 14

Total reactive energy consumption varh. The screen value here is 2.9516532.2 kvarh.



Figure 51: Menu 15

Voltage alarm AL.U is actived only if one of the phase voltages is not within the set limit. System power factor, Phase to phase voltage.



Figure 52: Menu 16

Maximum current among the three phases.  
 P = Peak.

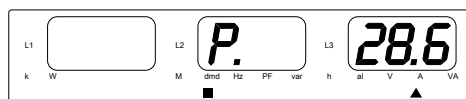

Figure 53: Menu 17

dmd<sup>1</sup>-value of maximum current among the three phases.

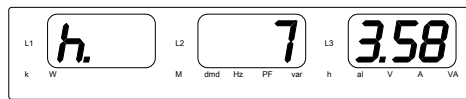

Figure 54: Menu 18

Total operating time. The screen here shows 73.58 hours.



# Xylem |'zīləm|

- 1) The tissue in plants that brings water upward from the roots
- 2) A leading global water technology company

We're 12,000 people unified in a common purpose: creating innovative solutions to meet our world's water needs. Developing new technologies that will improve the way water is used, conserved, and re-used in the future is central to our work. We move, treat, analyze, and return water to the environment, and we help people use water efficiently, in their homes, buildings, factories and farms. In more than 150 countries, we have strong, long-standing relationships with customers who know us for our powerful combination of leading product brands and applications expertise, backed by a legacy of innovation.

For more information on how Xylem can help you, go to [xylem.com](http://xylem.com)



Xylem Water Solutions AB  
Gesällvägen 33  
174 87 Sundbyberg  
Sweden  
Tel. +46-8-475 60 00  
Fax +46-8-475 69 00  
<http://tpi.xylem.com>

Visit our Web site for the latest version of this document and more information

The original instruction is in English. All non-English instructions are translations of the original instruction.

© 2011 Xylem Inc